



www.auc.ab.ca

MICRO-GENERATOR APPLICATION GUIDELINE

(Version 1.1)

September 1, 2011

1. Introduction	2
2. Purpose	2
3. Legal and related matters	2
4. Disclaimer	3
5. Micro-generators – types and size.....	3
6. Principal bodies.....	4
7. Process summary	4
8. Guidelines for filing the application notice (Form A)	7
9. Electricity compensation.....	13
Appendix A – Process flowcharts	14
Appendix B – Glossary	18
Appendix C – Contact and source information	22
Appendix D – Certification marks	23
Appendix E – Single-line diagram (indicate size)	25
Appendix F – Interconnection and operating agreement sample.....	27
Appendix H – Form A, Micro-generation project notice.....	34
Appendix H – Form B, Notice of dispute.....	35
Appendix H – Form C, Notice of complaint	36
Appendix I – How to apply for a BA code (Business Associate Identifier)	37
Appendix J – Electrical safety	40
Appendix K - Electrical contractor and electrical inspection.....	42

1. Introduction

Since 1998 Alberta has increased its renewable electricity generation by more than 77 per cent. Renewable energy now accounts for 13 percent of Alberta's total generating capacity.

The government of Alberta is committed to supporting the wider use of renewable and alternative energy. Through micro-generation (MG) regulation, Albertans now have a simplified interconnection process to connect their own environmentally friendly electricity to the grid. This dedication to green technology provides consumers with greater options to manage their energy needs, promote a green lifestyle and receive credit for exported electricity.

The AUC is overseeing the implementation of this regulation as well as developing processes to simplify approvals and interconnection agreements with customers and service providers.

(Statistics source: Alta. Govt. Press Release Feb 1, 2008.)

2. Purpose

Connecting a micro-generator (MG) to the grid requires careful consideration of legal matters, safety, equipment and installation.

This document is intended to provide an overview of the safety, electrical and procedural aspects regarding the development of MGs on private property. It provides a step-by-step summary and details of the processes required to obtain official permission and approval for MG installation. The document also addresses obligations of MG applicants, electrical contractors, energy retailers and wire service providers (WSPs) in meeting MG compliance and safety.

The goal of this document is to provide you with all the information you need to confidently complete your MG application.

3. Legal and related matters

Electrical installations are subject to strict legal and municipal regulations including relevant health and safety legislation. MG installers need to be aware of the requirements of relevant municipal permitting regulations, installation obligations, electrical safety

and manufacturer compliance. Before commencing work it is advisable to consider the matters covered below and note further details identified throughout the document.

a). Building regulations

Applicants need to contact their municipal development department to determine if a development permit is required.

Before installing MG equipment to a home or building, the installer needs to consider the structural condition of the building. Check with your municipal building safety authority to confirm any building regulations and to determine whether your MG system requires a building permit.

b). Electricity compensation

Applicants must notify their retailer of their MG installation. This will ensure applicants are registered as MG owners and paid for exported electricity.

c). Electrical safety

Installing a MG brings unique considerations for electrical safety. Precautions must be taken to avoid the risk of electric shock. It is strongly advised that a qualified Electrical Contractor install your MG.

d). Equipment certification

The installer must refer to the MG equipment and the manufacturer's installation document to confirm that the MG complies with all relevant provincial electrical safety requirements.

e). Additional requirements for wind MGs

Development of wind-powered MGs requires specific approval from NAV Canada, Transport Canada and Alberta Transportation. Approval ensures that MG installations comply with requirements of air navigation, aeronautical safety and highway development control.

f). MG approval

Approval for MG installation is provided by the WSP for mini MGs and by AUC for small and large MGs. application notices can be rejected by either the WSP or AUC if an applicant's MG fails to qualify as a renewable or alternative energy resource under the MG Regulation. Applicants can dispute any rejection with a complaint form. See Appendix H, Form C.

g). Rule 012: Noise Control

Wind turbine noise output can vary widely across different products. Most products sold today come with a noise rating. It is important to consider noise rating when purchasing a wind turbine.

All applicants must comply with requirements stipulated in [AUC Rule 012: Noise Control](#). Although mini MGs do not require AUC approval to connect to the grid, they are still required to adhere to Rule 012. Noise complaint issues will be dealt with in accordance with AUC Rule 012.

4. Disclaimer

This guide does not provide installation guidance nor is it intended as legal advice. All measures have been taken to provide sound advice and procedures. However it is the applicant's responsibility to ensure all legal, health and safety, and municipal requirements are adhered to as identified in this document. Concerns should be directed to your wire service provider, electrical contractor, equipment supplier and any governing body where safety codes and conduct are in question.

Note:

The terms applicant, MG owner, MG proponent, you and your, are interchangeable throughout this document for ease of readability.

5. Micro-generators – types and size

Types

A range of simple, safe and reliable MG technologies are available for domestic use. These primarily include solar PV (photovoltaic), hydro, wind, biomass and fuel cell. Micro gas turbines are available for MGs greater than 10 kilowatts (kW).

Size

In Alberta, MG size is defined as being one megawatt (MW) or less. This document deals with three categories of MGs. Mini: inverter-based and less than 10 kW, small: 10 kW to 150 kW, large: 150 kW to one MW. **Most applicants will fall under the mini category.** See Glossary in [Appendix B](#) for details.

Generator Classification	Rating
Mini MG	≤ 10 kW, Inverter based
Small MG	≥ 10 kW but < 150 kW
Large MG	> 150 kW but < 1 MW

Table 1. Generator Classifications

TYPICAL MICRO GENERATION SYSTEM

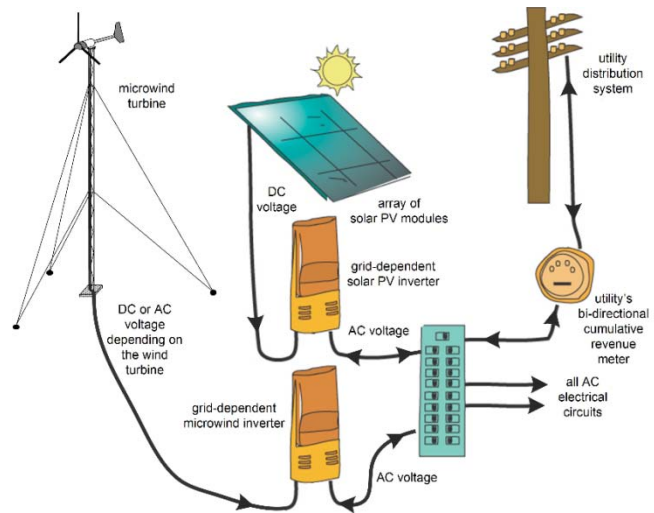

Figure 1. Typical wiring connections for a grid-connected micro wind and solar PV system. (Source: Modified from an unknown source. Gratefully included in this document.)

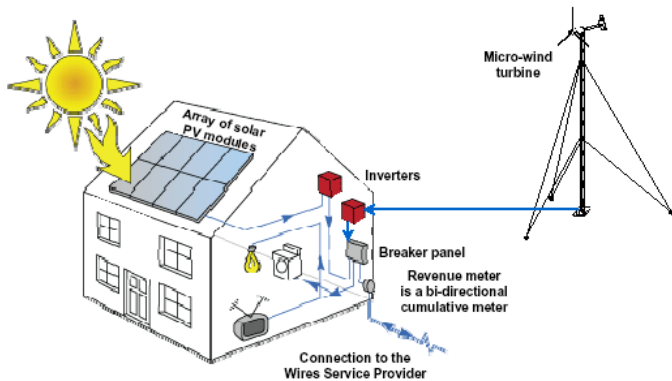

Figure 2. Typical residential grid connected micro-wind and solar PV system configuration. (Source: Alberta Solar Municipal Showcase)

Note:

- The solar PV and micro wind systems illustrated above are included only to show how they are configured. Having both systems is not typical.
- These systems can operate in parallel with each other, but are otherwise not interconnected.
- A battery bank may also be included.
- Excess electricity is exported to the grid.
- Additional electricity is supplied from the grid.
- Electrical energy is purchased from and sold to the energy retailer at standard retail rates as per their approved tariffs.

6. Principal bodies

Since the MG system will be connected to the electrical distribution grid, several governing bodies are involved in ensuring the system’s safety, processing of approvals and administration. These include:

Alberta Utilities Commission – AUC
Approves the development of small and large MGs.

Alberta Electric System Operator – AESO
Operates the wholesale electricity market that determines the amount paid to MG systems with interval meters.

Energy retailer
Sells deficit electrical energy to, and buys exported electrical energy from, the MG owner.

Electrical inspectors

Ensures that Canadian Electrical Code standards are met for all electrical installations.

Wire service provider - WSP

Provides the grid connection to the MG.

See the process charts in Appendix A for an overview of each governing body’s role during the MG approval, development and installation process.

See the Glossary in Appendix B for descriptions of each principal body.

7. Process summary

This summary section provides a quick snap shot of what steps you need to follow and in which order. Where necessary, further details are provided in this Application Guideline. Most applicants will qualify as micro- or mini -generators.

Legend

Colour codes and stars denote MG size. Where no star is used, the step applies to all MG sizes.

	Mini MG (under 10 kW)
	* Small MG (10 kW to 150 kW)
	** Large MG (>150 kW and < 1 MW)

a) Plan your micro-generator installation

Follow the regulations and guidelines provided in this document. If you do not have the complete document, contact Alberta Utilities Commission for a copy. Consult with your neighbours and any landowners or residents that will be affected (visually for solar installations or visually and by noise for wind turbine installations). Check municipal permit requirements and if you are a wind proponent check municipal noise by-laws.

b) Contact your wire service provider

Applicants must contact their WSP and inform them of the plans to install a MG. Request a MG information package and confirm all information they require. See the WSP Contact link in Appendix C.

If the micro-generator capacity is less than 10 kW, the WSP will assess the application and provide approval for connection.

If the micro-generator capacity is over 10 kW, the WSP will conduct a preliminary assessment to determine if the proposed MG project meets the MG requirements. Once the project status is determined, the MG proponent is responsible for an application submission to the AUC for approval. The MG proponent must follow the process outlined in section 4 of AUC Rule 007: *Small Power Plant Application Less Than 1 MW* (see link: <http://www.auc.ab.ca/acts-regulations-and-auc-rules/rules/Documents/Rule007.pdf>)

c) Micro-generator information package

Review the MG information package received from your WSP. The information package is extensive. All documents should be reviewed thoroughly. The package will consist of equipment safety and requirement information along with an interconnection agreement. It is advised that applicants download and read the WSP terms and conditions document. See [Appendix F](#) for sample interconnection agreements.

d) Electrical consultation

Consult with one or more qualified electrical contractors. It is recommended that all electrical work be done by a qualified and experienced electrical contractor. Installing a MG is beyond the scope of most do-it-yourself projects.

e) Confirm your legal land description

Your legal land address is required. If you do not know this information, contact an Alberta Registry agent, taxation office or the Alberta Motor Association for help. See [Application Guidelines](#).

f) Obtain municipal permits

Contact your municipality permit office to confirm whether a development permit, building permit and emergency response plan are required. See [Application Guidelines](#).

Note:

Some municipalities may not permit wind MGs to be installed on residential properties in urban municipalities.

g) Additional requirements for wind MGs

Wind MGs require approval from additional regulatory bodies including NAV Canada, Transport Canada and Alberta Transportation. See [Application Guidelines](#) for details.

Wind proponents also need to be aware of AUC Rule 012: *Noise Control*. Proponents are required to comply with the noise bylaws of their municipality as well as AUC Rule 012. More information on Rule 012 is available through the link in Appendix C of this document.

h) Prepare site plan

Prepare a basic site plan showing where the MG will be located. This will be required for the municipal development permit for all MG sizes and by the AUC (if installing a small or large MG.) See [Application Guidelines](#).

i) Prepare a single line diagram (SLD)

It is advised that an electrical contractor completes the SLD, and submits the SLD to an electrical inspector for approval. See [Application Guidelines](#) and the SLD Forms in [Appendix E](#). Select whichever SLD is appropriate for your MG or generate your own.

j) Confirm equipment certification

Physically check the electrical certification mark on all equipment to ensure it is approved to the appropriate Canadian standards. See [Appendix D](#) for a list of approved certification marks.

k) Complete the micro-generator application notice

Complete the [MG Application Notice Form](#) attached at the end of this document.

l) Submit the micro-generator application

Submit the application to your wire service provider

Applications that are more than 10 kW must submit the MG application notice and documentation to the AUC. See the Appendix for a link to the Digital Data Submission program that you will use to submit your application to the AUC. The application will include some or all of the following additional documents:

- Site plan
- Single line diagram
- Development permit (if required)
- Building permit (if required)
- Wind documents (if required)

See [Application Guidelines](#) for details.

m) Obtain a Business Associate code * **

Business Associate (BA) codes are required by the AUC for small or large MGs application notice submission. Complete the BA code application form online at the Petroleum Registry website (These codes are managed and assigned by the Petroleum Registry of Alberta). https://www.petroleumregistry.gov.ab.ca/prs/IFDBASSC_00_FRM_ManageBA.aspx

Phone 403-297-6111 or 1-800-992-1144 or email: petroleumregistry.energy@gov.ab.ca for the Registry Help Desk. You should receive your BA code in a couple of days.

Appendix I illustrates how to obtain a BA code.

n) Application review

Application notices are received and reviewed by the WSP. The WSP can reject the application if it does not meet the MG Requirements. If they accept the application then the development of the MG installation proceeds for those MG applications less than 10 kW. MG proponents are still responsible for application submission to the AUC for installations more than 10 kW, following the process defined in AUC Rule 007.

o) Micro-generation proponent forwards documentation * **

For small and large MG application notices, MG proponents are responsible for preparing and submitting documentation to the AUC for approval. WSPs should also be kept informed.

p) AUC approval * **

As noted in the process flowcharts in [Appendix A](#), MG proponents have to obtain approval from the AUC before the construction of small or large MGs is permitted.

q) Wire service provider approval

For a mini-MG, WSPs will provide applicants with confirmation that the MG application notice is approved and will be grid connected.

r) Select Your electrical contractor

s) Obtain Your electrical permit

An electrical permit is required before any work can be done to install your MG. The person doing the

electrical work must obtain the electrical permit. A permit is issued by each municipality. If applicants are using an electrical contractor, then the contractor will obtain the electrical permit.

t) Install Your micro-generator

It is strongly advised that applicants hire a qualified electrical contractor to install the MG.

u) Application for electrical inspection

After the MG is installed, an application for inspection must be submitted (by the person with the electrical permit) to the municipality's electrical inspection contractor. If the installation passes the electrical inspection, then an inspection report will be provided by the municipality. If an electrical contractor completed the application for inspection, applicants should obtain a copy of the certificate of inspection.

v) Contact your energy retailer

Following completion of the electrical inspection and the issuance of an inspection report, applicants must contact their energy retailer to: a) advise them of the MG connection date, b) arrange compensation for extra electricity generated by their MG. See contact link in [Appendix C](#) for a list of energy retailers.

w) Submit a copy of the certification of inspection to your wire service provider

WSPs will require a copy of the certificate of inspection before they will finalize the connection agreement with applicants.

x) Meter or service line modifications

The WSP makes any modifications that may be required to the meter or electrical service entrance. Where necessary, applicants will be offered either a bi-directional cumulative meter or two one-way (detented) meters. If two one-way meters are used, then a second meter base will need to be installed (by the WSP) at the service entrance. The capacity of the service entrance will be increased to accommodate the MG (if required).

y) Compensation for exported electricity

Energy retailers buy the MG owner's (applicant's) exported electricity. Under the *MG Regulations*, energy retailers will facilitate payment for excess energy generation through the Alberta Electric System Operator (AESO). See [electricity compensation](#) later in this document.

8. Guidelines for filing the application notice (Form A)

The following guidelines provide detailed information to help applicants complete the application notice form as easily as possible. Additional sources are identified throughout this section so you can access any required information.

A. APPLICATION IDENTIFICATION

Name of Applicant

Enter the name you want to appear in legal documents.

Company Name if Applicable

Enter the company name you want to appear in legal documents if a company is responsible for owning and operating the MG.

Address1

Enter the street address for your home residence or company address.

Mailing Address

Enter the mailing address if different from street address.

Phone

Enter a weekday phone number.

Email

Enter your personal or company email address. Be sure that the email address can safely receive MG documentation without risk of being blocked by junk email blockers. Email from the AUC, Alberta Energy or other organizations involved in the MG application notice process may be sent to you periodically.

By submitting the MG application you agree to receiving information and updates pertaining to MGs.

Consultant Name if Applicable

Enter the name of the person or company who has aided you in completing your MG application if applicable. The consultant will be regarded as the second line of contact in the event we cannot reach you and/or need any clarification.

Consultant Address

Enter your consultant's current business mailing address including postal code.

Consultant Phone

Enter your consultant's day time phone number including area code.

Other Interested Parties

Enter the names and contact information of any other parties who may have a say in the functioning, legalities or aesthetics of the MG. This could include a neighbour, property owner or business partner.

B. PROJECT DESCRIPTION

Legal Land Description

In rural areas enter the legal land description. is a term used to describe sections of land you have title to for the purpose of government records. This information may be found on your land title, tax assessment or mortgage agreement.

If you have an urban address, enter the lock, block and plan of your MG location. If you have a rural address enter the quadrant, section, township, range and meridian location of land as per the example below.

Example:

Quadrant	Section	Township	Range	Meridian
SW	18	57	7	W4

The example above uses the rural address for the Southwest Quarter of Section 18, Township 57, Range 7, West of the Fourth Meridian. It would be shown as **SW18-57-7-W4**.

If you do not have this information contact your local taxation office, the Alberta Motor Association or an

Alberta Registries agent for help. Your street (civic) address will be required to perform a search. Searches can be done for most urban areas with the exception of most condominiums. There is a nominal fee for this search.

Alberta Motor Association
<http://www.ama.ab.ca>

Alberta Registries
<http://www.servicealberta.gov.ab.ca>

Site ID

Enter your site identification number. Site identification numbers are required for each electrical installation in Alberta. You can find your site ID number on your electric utility bill.

New utility installations require obtaining a new site ID. Contact your WSP and inform them that you are planning a MG site. You will be required to complete a site ID form. Your building permit number and/or electrical permit number may be required to complete the site ID form.

See Contact link in [Appendix C](#) for a list of WSPs.

Service Address

Enter the service address where you plan on installing the MG.

Examples:

Home installation

If you want to install a solar PV system on your home, you would enter your home address.

Rural/farm installation

If you want to install a wind turbine on your farm, enter the address of where your turbine will be placed on your property including the location latitude and longitude.

You can find the exact latitude and longitude by looking online at Google Earth or by using a global positioning system (GPS). A GPS or surveying company can also help with this.

Retailer Name

Enter the name of your energy retailer. Look at your electric utility bill for the energy retailer or see the

Contact link in [Appendix C](#) for a list of energy retailers.

Notifying your energy retailer about your MG

Since your energy retailer is the company who sells you your electricity and who will purchase your exported electrical energy, they need to be notified about your MG. Your retailer will arrange financial compensation for excess electricity generated through your MG. They will make the necessary arrangements with AESO. You will need to provide your retailer with the following information:

1. Notice that you intend to install a MG.
2. The type of micro-generator you will be installing (i.e. solar, wind, fuel cell, etc).
3. The start date of installation.

Generator Type

Select the type of MG that you are installing. If your MG is not listed select 'Other' and provide specific details on the generator type.

Application notices are limited to one MG. If you are installing more than one MG you must submit a separate application notice for each. See the Glossary in [Appendix B](#) for a description of each generator type.

Generator to Utility Interface * **

Electrical equipment, appliances, tools, machines and lights connected to the wiring in your home, farm or business use alternating current (AC) power supplied by your energy retailer and delivered by your WSP.

Interconnection of an alternative energy system to the utility grid will require a particular type of interface. The type of interface you choose will depend upon your type of generator. The majority of mini and small MGs on the market today are inverter based.

Of the two types of inverters, most scenarios will involve a current source inverter.

1. Current source inverter – An inverter where the DC link has a constant current, usually by way of an inductor.
2. Voltage source inverter – An inverter where the DC link has a constant voltage, usually by way of

a bank of capacitors, battery cells, or other electrical storage device.

Non inverter

This is a special interface that is mated to an induction or a synchronous generator. It causes the generator to behave like a certified grid-connected inverter – where it is certified to shut off automatically during outages on the electrical distribution system and contains islanding detection and shut down equipment in the highly unlikely case that an electrical island occurs.

Induction

An induction generator is a type of electricity generator that converts rotational energy into electricity and requires an external voltage source to energize its windings.

Synchronous

A synchronous generator is a type of electricity generator that converts rotational energy into electricity independent of any external voltage source.

For a small MG, indicate if the generator to utility interface is inverter or non-inverter based. For a large MG, indicate if the generator to utility interface is an induction or synchronous generator.

Generator Rated Capacity (kW)

Enter the rated capacity of your generator. Your MG equipment will identify the kW capacity on its name plate.

Demand (kVA) **

This is the maximum amount of apparent electrical energy consumed and measured in kVA (kilovolt amperes). The kVA of your Large MG will be identified on your equipment.

Customer Annual Usage or kWh

A kWh (kilowatt hour) is the basic unit of electricity energy. For items using constant power, total energy usage in kWh is simply the energy used (in watts) multiplied by hours of use.

When you buy power from your utility company it is sold to you at a certain rate per kWh. The kWh amount will be identified on each monthly electrical bill. Add the amount identified on each monthly bill for the year to get your total annual usage.

Voltage Level of Connection

Your equipment supplier or electrical contractor will provide you with the required voltage level of connection. For example, a house always uses 120 or 240 volts and a mini MG installed on a house would likely be connected at 240 volts. MG owners are responsible for ensuring that the voltage levels at the point of interconnection are maintained.

Single or Three Phase

Single or three phase relates to how power is delivered to your site. Enter whether your electrical energy is delivered using single or three phase voltage and current timing.

In most cases mini and small MGs will select single phase and large MGs will select three phase. Contact your WSP for confirmation. See contact link in [Appendix C](#) for a list of WSPs.

Is the energy produced to be used primarily by the generator owner?

If the electrical energy you generate is for personal home or farm use to reduce your electricity bills, select Yes. If the energy is intended for commercial operation or primarily for sale to the electrical market, select No.

Does your generator unit satisfy Anti-Islanding Clause CSA C22.2 No. 107.1? **

In order to meet the anti-islanding clause, your MG must meet specific electrical safety codes and product performance standards. Safety and performance standards are required to ensure the safety, power quality and interconnection aspects of your MG so it doesn't compromise the safety and electrical power quality of the utility grid.

The nameplate on your MG equipment and its installation manual should identify the following code: CSA C22.2 No.107.1. If this code is labelled on your equipment, select Yes. If this anti-islanding code is not identified, select No.

What is anti-islanding?

Anti-islanding is a function that shuts down the operation of a MG during an emergency or utility power outage. Its purpose is to protect WSP line workers from accidentally working on energized electrical distribution lines.

What is islanding?

An electrical island is where a portion of the WSPs electrical distribution system that contains both electrical loads and electrical generators is isolated from the remainder of the distribution system, but remains energized.

The safety concern is that if an electrical outage occurs (perhaps in the event of a major storm), a MG could continue to unintentionally supply electrical power to the island. While a WSP can be sure that all of its own energy feeds are either shut down or isolated from the area that needs work, an island created by a MG can be out of their control.

The principal concern is that a WSP line worker will come into contact with a line that is unexpectedly energized. Although line workers are trained to test all lines before working on them, all measures and precautions must be taken to ensure the removal of all risk.

How does anti-islanding work?

Technology developed for grid-connected MGs is now specifically designed so that there is practically no chance of an island stemming from a MG. Grid-connected inverters monitor the utility line and cease to deliver electrical energy to the grid in the event that an outage occurs.

Large MGs need to follow additional Canadian Electrical Code (CE Code) regulations. Contact your electrical contractor and WSP for details.

Meets MG renewable energy definition?

Renewable or alternative energy means electric energy generated from solar, wind, hydro, fuel cell, geothermal, biomass or other generation source where the electric energy produced provides a greenhouse gas intensity less than or equal to 418 kg per MWh and includes:

- Electric energy generated from products having a current EcoLogo certification
- Simultaneous generation of electric energy and production of thermal energy from the same fuel source, in which case the greenhouse gas intensity of the total energy produced must be less than or equal to 418 kg per MWh. (*AUC Micro Generation Regulation – Energy Utilities Act*)

If your MG is solar, wind or hydro, select yes. If your MG is biomass, fuel cell or other you will need to verify whether your equipment meets greenhouse emission requirements with your equipment supplier.

Requested in Service Date (MM-DD-YY)

Enter the start date of operation for your MG.

C. SUPPORTING DOCUMENTS

Electric single line diagram

An electric single line diagram (SLD) provides a basic connection configuration between the electrical components of your MG and your WSPs electric distribution system.

This handbook comes with example SLDs for your use. See [Appendix E](#).

- Include the wire service provider's technical recommendations in your SLD.
- Phone your municipality for a list of electrical inspectors in your area.
- Since MGs are not common, we recommend that you submit your SLD to an electrical inspector for review and comments.
- Submit your SLD to your electrical contractor for review.
- Applicants or a contracted electrical contractor will be required to submit an application for inspection

to the municipality's electrical inspection contractor.

Site Plan

A site plan is a drawing of your property showing the property lines, any structures that currently exist on your land (house, garage, fence, etc) and where your proposed MG is to be located.

The site plan will be needed for any municipal development permit for all MG sizes and by the AUC (if installing a small or large MG.)

A copy of your real property report is adequate as the basis for the site plan for your MG application. For more information on real property reports, go to:

<http://www.alsa.ab.ca/real-property-reports>

A site plan should include:

- An arrow indicating north.
- The scale of the drawing (for example, one inch to 10 feet).
- Property lines.
- Adjacent streets.
- Distance between buildings and between buildings and property lines.
- Dimensions of existing buildings.
- Location of your MG.
- Other appropriate items for your project.

Existing engineering aerial drawings can be used. You can also get a great photo of your site from space on Google Earth (<http://earth.google.com>).

Has an electric permit been obtained?

An electrical permit is required for any major electrical work. An electric permit is a legal document that ensures that your MG is inspected and thus meets the Canadian Electrical Code. Applicants may apply for the electrical permit and do the electrical work if they own and live in their home. It is advised that applicants contract a qualified electrical contractor.

Obtaining an electric permit

See the Alberta Municipal Affairs website for the Permit Information Search tool that will direct you to your respective municipality.

http://www.municipalaffairs.gov.ab.ca/cp_permit_information_search.cfm

Alberta Municipal Affairs Communication and Inquiry Centre at 1.866.421.6929 or
Email: safety.services@gov.ab.ca.

Finding rules, regulations and permit links
Go to the Safety Codes Council site at
<http://www.safetycodes.ab.ca/>

Have you met all applicable municipal and zoning requirements and permits?

In most cases municipal and zoning requirements and guidelines will be identified in your development permit. If you do not have a development permit at the time of application, you must provide the permit prior to your MG installation or indicate why your municipality doesn't require it.

Land use bylaws are dependent upon your municipality. For example, does the zoning for your house permit allow you to install a wind turbine in your neighbourhood?

Contact your municipality's permit office to confirm all applicable bylaws in regards to your MG. Ask them whether a development permit, building permit and emergency response plan are required along with any other requirements deemed necessary, along with what steps to take to acquire them.

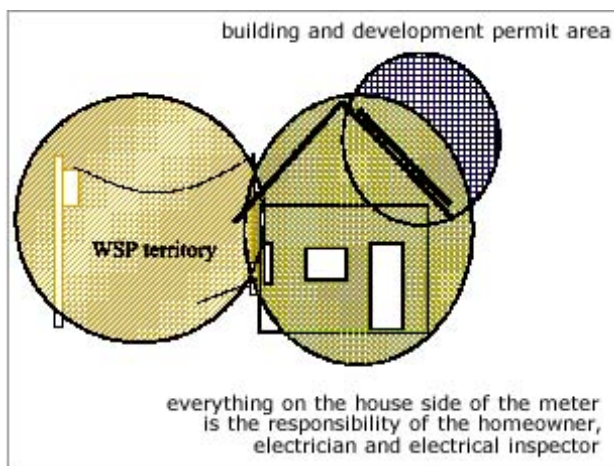

Figure 3: Areas of responsibility for the WSP, homeowner and municipality for a solar PV system on a house
(Source: Boyd Solar)

Additional wind power requirements

Developing wind power MGs requires specific approval from several agencies including NAV Canada, Transport Canada and Alberta Transportation.

The following steps must be taken in order to receive approval from these agencies:

1. NAV Canada

Wind turbine blades can adversely affect air navigation in certain locations. Applicants must complete NAV Canada's Land Use Proposal Submission Form and obtain their approval for a wind MG. Applicants must aware of the AUC Rule 012: *Noise Control*.

Go here for information:
<http://www.navcanada.ca>

Go here for the application (click on Wind Farm Template):
<http://www.navcanada.ca/NavCanada.asp?Language=en&Content=ContentDefinitionFiles\Services\LandUseProgram\FormsReference\default.xml>

2. Transport Canada

Wind turbines can be an aircraft hazard in certain locations. Applicants must complete Transport Canada's Aeronautical Obstruction Clearance Form and obtain their approval for a wind MG.

Go here for Information:
<http://www.tc.gc.ca>

Go here for the application:
http://www.tc.gc.ca/wwwdocs/Forms/26-0427_0711-02_BO.pdf

3. Alberta Transportation

Approval is required for wind turbines located within 300 metres of a numbered highway or 800 metres of an intersection of the numbered highway with another public road. Applicants must complete the Alberta Transportation form titled Roadside Development Application for Development near a Primary Highway and obtain their approval for a wind MG.

Go here for Information:
<http://www.transportation.alberta.ca/>

Wind turbine proponents must also comply with their relevant municipal noise by-laws, as well as AUC Rule 012: Noise Control. The noise ratings of different wind turbines should be kept in mind when deciding which product to purchase.

Go here for the application:
<http://www.transportation.alberta.ca/Content/docType329/Production/rdpapp.pdf>

9. Electricity compensation

When an MG generates more electricity than is being consumed or stored, the surplus will (and must in most cases) be fed into the WSP's electrical distribution system. Applicants are paid by their energy retailer for the surplus exportation of electricity. Applicants must contact their energy retailer to arrange for their electricity compensation.

Mini MGs will be paid for their exported electrical energy based on the same price of the electrical energy that they are purchasing from their energy retailer. Note that this price does not include the price of delivering the electrical energy to the MG owner site. The WSP will provide you with either a bi-directional cumulative meter (in most cases) or two one-way meters (known as detented meters) that will measure how much you import into your site and separately measure how much you export onto the electrical distribution system.

For MGs that use interval meters instead (ones that record the electrical energy flow every 15 minutes) then you will be paid the system marginal price of Alberta's wholesale electricity market. This price is shown in units of \$/MWh (megawatt-hours), which can easily be changed into ¢/kWh by dividing by 10. There are 1,000 KW/h to one MW/h. Divide the pool price by 1,000 to get a per KW/h rate. (i.e. \$60 pool price will equal \$0.06 in KW/h). The price varies every few minutes according to supply and demand and is often seen as low as one cent per kWh in the evenings and can be as high as \$1 per kWh in emergency supply situations.

Go here to view the current pool price:
<http://ets.aeso.ca>

Go here for more information about how the pool price is calculated - "Determining the Wholesale Market Price for Electricity":

http://www.aeso.ca/files/fastfacts_det_market_5_may06.pdf

Visit the AESO website for additional information:
<http://www.aeso.ca>

13. Obligations

Micro-generator owner obligations

- All costs of operating the MG are the responsibility of the MG owner as per the WSP interconnection agreement.
- Contact your neighbours and those affected by your proposed installation and notify them of your intent to install MG equipment.
- If your Application Notice is for MG over 10 kW, you must follow AUC Rule 007, Section 4 and submit your application notice to the AUC.
- Contact your WSP to notify them of your intent to install a MG.
- Contact your energy retailer to inform them of the MG installation date.
- Complete all steps as required described in this Micro-Generator Application Guideline document. Wind proponents are required to complete NAV Canada, Transport Canada, and Alberta Transportation application forms (links to which are found in Section 11, Additional Wind Power Requirements).
- Application notices are limited to one generator type per site. If you are installing more than one MG you must submit a separate application notice for each MG.

Retailer obligations

- Act as a participant of AESO's electricity market by crediting the applicant for excess exported electricity.
- Ensure that exported electricity will incur a credit on the applicant's bill to be carried forward to the next bill.
- Ensure unused credits are paid to applicants once a year or as negotiated.

Wire service provider obligations

- Responsible for determining whether a MG qualifies as a renewable or alternative energy resource under the MG regulations.
- Install appropriate metering that will separately measure the imported and exported electrical energy.
- Cover all the metering, meter data handling and any installation costs incurred by the MG. These costs are to be added to the rate base and recovered from all customers.
- Provide applicants with an interconnection agreement upon MG approval.
- Provide applicants with a letter confirming their MG approval and grid connection.

Electrical contractor obligations

- Obtain an electrical permit and electrical inspection for their MG electrical work.
- Install MGs in conformance to their designs and the Canadian Electrical Code.

Appendix A – Process flowcharts

Mini Micro-generator

MG Application Process - Less than 10 kW Inverter Based

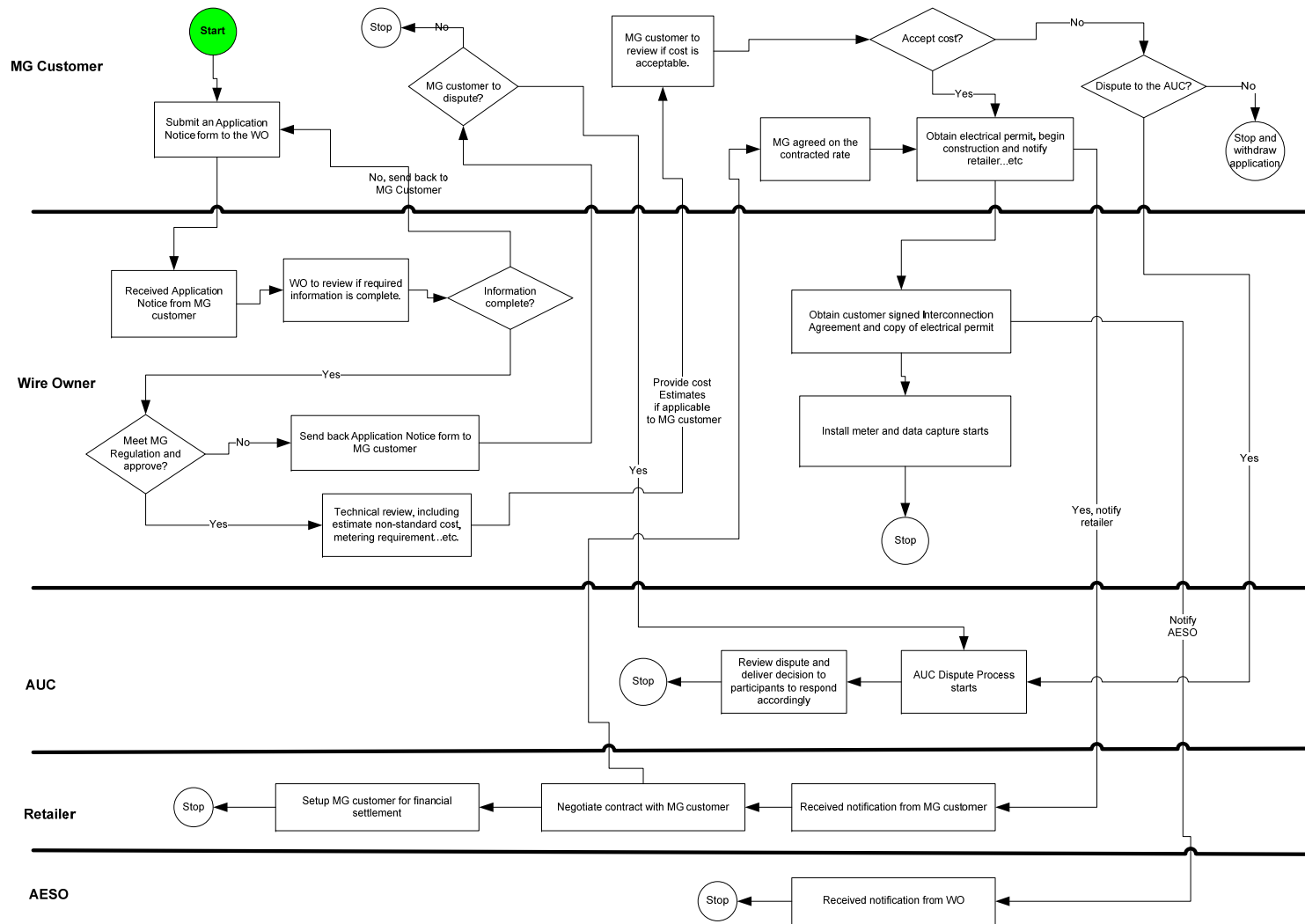

Small Micro-generator

MG Application Process – Less than or equal to 150 kW

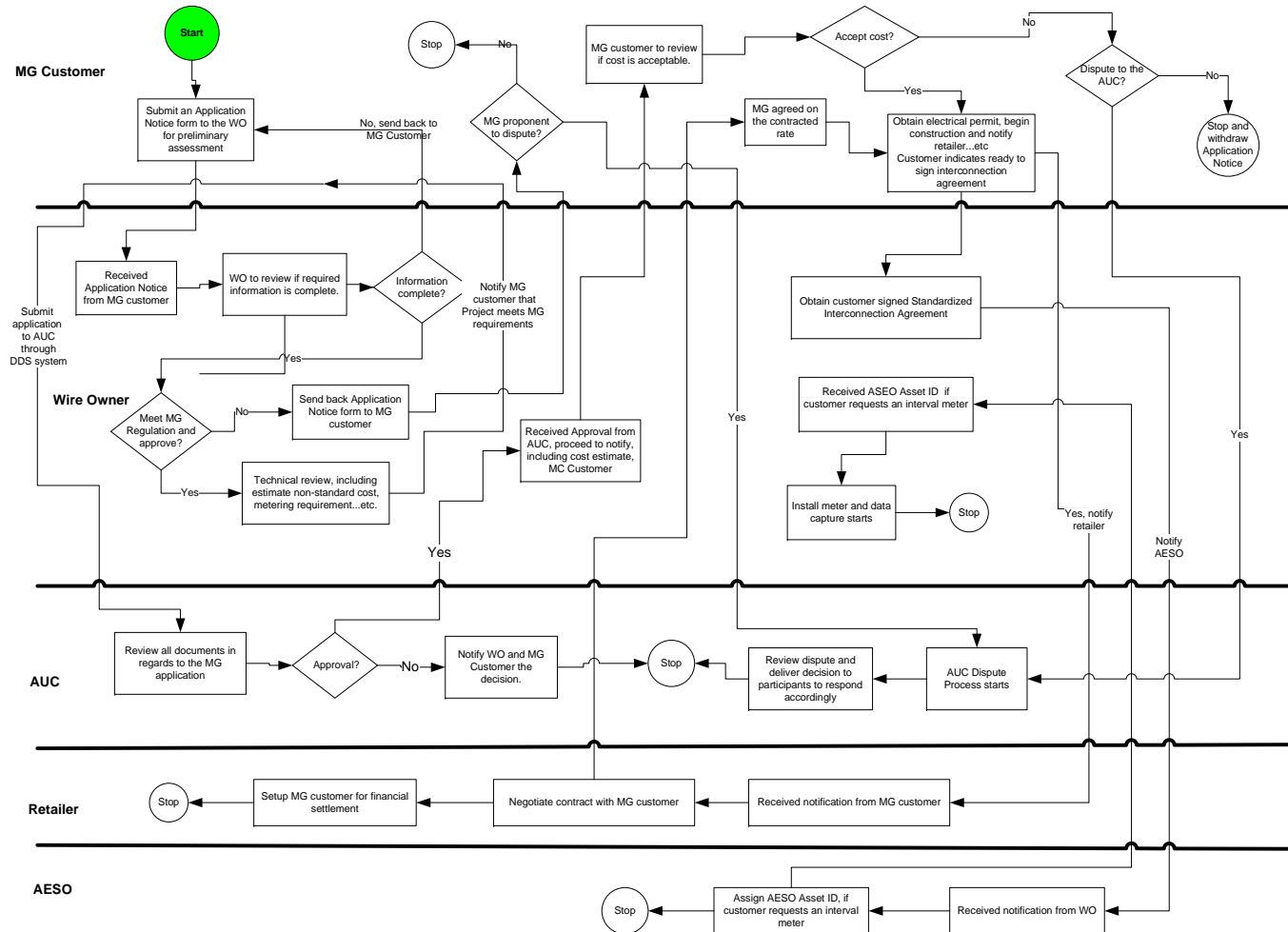

Large Micro-generator

MG Application Process – Greater Than 150 kW and ≤ 1 MW

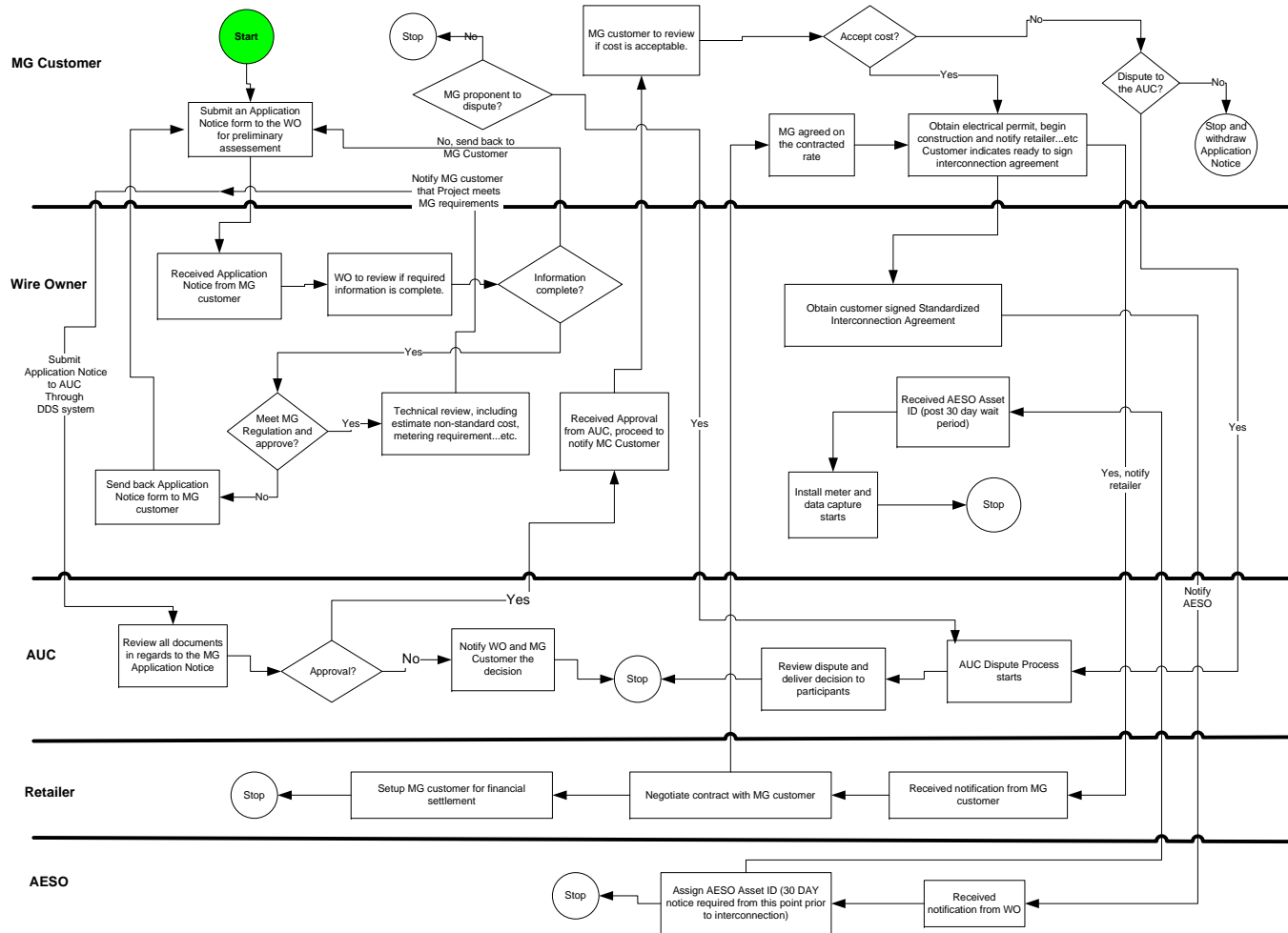

Appendix B – Glossary

Alberta Utilities Commission (AUC)

Independent, quasi-judicial agency of the government of Alberta that regulates Alberta's electric utilities to ensure safe and reliable delivery of utility services that are in the public interest at just and reasonable rates. Website: www.auc.ab.ca.

Alberta Electric System Operator (AESO)

Independent not-for-profit company established by the government of Alberta to govern the safe, reliable and economic planning and operation of Alberta's electrical transmission system, offer open transmission system access for large companies, develop and administer transmission tariffs, and operate the wholesale electricity market.

Alternating current (AC)

Electric current that regularly reverses its direction of flow, which in Canada is at 60 times per second.

Anti islanding

Technology in a micro-generation system that prevents it from feeding electricity into a distribution system during a utility electrical outage. Its purpose is to protect utility workers from working on a live distribution system.

Approved electrical equipment

Electrical equipment that bears a legal certification mark from one of the accredited certification organizations and is affixed to the nameplate on the electrical equipment. See Appendix B.

Note: The presence of such a mark indicates that the equipment is in compliance with an appropriate product standard in Part 2 of the Canadian Electrical Code. If the equipment does not have one of these certification marks it is not legal to sell or use it. (Refer to Appendix B or Electrical Safety Information Bulletin STANDATA LEG-ECR-2 from Alberta Municipal Affairs for examples of accepted legal certification marks.)

Bi-directional cumulative meter

Electricity-measuring device that measures in two separate data points the total electricity that has flowed in a circuit from one reading date to the next. One data point shows the amount of electrical energy that has been exported to the grid. The other data point shows the amount of electrical energy that has been imported from the grid.

Bi-directional interval meter

Electricity-measuring device that measures in two separate data points the total electricity that flows in a circuit between intervals of usually 15 minutes. One data point shows the amount of electrical energy that has been exported to the grid. The other data point shows the amount of electrical energy that has been imported from the grid.

Biomass generator

Generator that uses biomass products such as wood logs, wood chips, wood pellets, miscanthus (elephant grass) or straw as its energy source.

Canadian Electrical Code (CE Code or CSA C22.1)

Standard published by the [Canadian Standards Association](http://www.csa.ca) for addressing electrical safety, shock, and fire hazards of electrical products in Canada.

Commission

Common reference to the Alberta Utilities Commission (AUC).

Current source inverter

An inverter where the DC link has a constant current, usually by way of an inductor.

Direct current

Electric current that flows in one direction.

Disconnect

To turn off the electrical current in a circuit.

Disconnecting means

Electrical components such as switches that provide a disconnecting function.

Distributed generator (DG)

Electric generator that is connected to a distribution system.

Distributed generator (DG) source disconnect

A disconnecting switch placed between a generator's output terminals and the wiring of its electrical loads and a distribution system.

Distributed generator (DG) system disconnect

A disconnecting switch placed between a generator's output terminals and a distribution system required to ensure the safety of electrical utility workers.

Distribution panel

Electrical box that contains over-current devices between its source circuit and a building's branch electrical circuits.

Distribution system

Electrical lines and equipment typically operating at less than 25,000 volts that manage and distribute electrical energy from a substation to customers.

Electrical wiring

Components that are intended to carry electrical current.

Electric single-Line diagram (ESLD)

Basic roadmap made up of single lines and graphic symbols that show the interconnections of the electrical circuit or system of circuits.

Energy retailer

Either an independent government-licensed electricity marketing company that supplies electricity at competitive unregulated prices to its customers, or an entity appointed by the Wires Owner to provide a regulated rate option to customers. Both entities bill the customer for energy consumption and wires charges.

Fuel cell generator

Generator that has hydrogen as its energy source and employs a non-combustion electrochemical reaction as the energy conversion mechanism

Generator

Device that converts energy from one form into electrical energy.

Generator rated capacity (kW)

Basic measurement unit for electrical energy. It is the rate at which electrical energy is produced by a generator at a defined set of operating conditions. A kWh is simply the rate (measured in watts) at which

electrical power flows in a circuit multiplied by the time (measured in hours) that the power is flowing at that rate. For example, one kWh equals 1,000 watts flowing for one hour, or 100 watts flowing for 10 hours.

Note: The rated output is less than but usually close to the maximum output.

Grid-connected inverter

Inverter that is able to operate in parallel with a distribution system.

Note: A grid-connected inverter is also known as a grid-intertie or a grid-tied inverter.

Grid-dependent inverter

Grid-connected inverter that operates only in grid-dependent mode and depends on the power from the utility grid to initiate and continue the inverter's operation.

Hydro generator

Generator that uses moving water as its energy source.

Inverter

An inverter is an electronic device that converts DC electricity into AC electricity and acts as the interface between your electricity generator and the WSP's electrical distribution system. Electricity from your generator (solar PV, fuel cells, wind turbine etc) is converted to a form that can be supplied to the utility grid.

Independent system operator (ISO)

Company responsible for the safe, reliable and economic planning and operation of the Alberta Interconnected Electric System (AIES). In Alberta this service is provided by Alberta Electric System Operator (AESO).

Induction generator

Device that converts the mechanical or rotational energy into electricity based on electromagnetic induction.

Islanding

Portion of the electrical distribution system that contains both loads and generators and is isolated from the remainder of the distribution system, but remains energized. Islanding is not permitted in Alberta.

Micro-generator

Typically a residential or small commercial generator with a capacity less than one MW that is connected to the electrical distribution system. The electricity produced is for personal use and it is generally expected that on an annual basis generation will be equal to consumption.

Mini micro-generator

A technology which has proven (by an independent third party) to act like an inverter with a generation capacity of no more than 10 kW of electrical energy. It generates or proposes to generate electric energy primarily for the customer's own use.

NAV Canada

A private, non-share capital corporation that owns and operates Canada's civil air navigation service.

Overcurrent device

Electrical fuse or circuit breaker

Renewable or alternative energy

Electrical energy generated from solar, wind, hydro, fuel cell, biomass or other generation source where the greenhouse gases associated with its generation have a production rate less than or equal to 418 kg of greenhouse gases per MWh of electrical energy generation.

Retailer

See energy retailer

Revenue meter

Single bi-directional meter or two one-way meters; one for import and one for export. The meter measures the electrical energy (and other characteristics of electricity) that flow between a distribution system and a customer. The data is used to generate a bill or credit to the customer. Revenue meters are owned and maintained by wire service providers and must be approved by Measurement Canada.

Single-phase inverter

Inverter that generates single-phase electricity.

Solar photovoltaic generator

Generator that uses solar radiation as its energy source.

Stand-alone inverter

Inverter that supplies a load not connected to a distribution system.

Synchronous inverter

Electrical inverter that changes direct current (DC) electricity to alternating current (AC) electricity.

Three-phase (multi-phase) inverter

Inverter that generates three-phase electricity.

Voltage source inverter

An inverter where the DC link has a constant voltage, usually by way of a bank of capacitors, battery cells or other electrical storage device.

Wind generator

Generator that uses moving air as its energy source.

Wire service provider (WSP)

Company that operates and maintains a distribution system.

Appendix C – Contact and source information

Alberta Department of Energy (DOE)
<http://www.energy.gov.ab.ca>

Alberta Department of Energy (DOE) Key Initiatives
[Alberta Energy: Alberta Energy Publications](#)

Alberta Electric System Operator (AESO)
<http://www.aeso.ca>

Alberta Municipal Affairs
<http://municipalaffairs.gov.ab.ca>

Alberta Safety Codes Council
<http://www.safetycodes.ab.ca>

Alberta Utilities Commission (AUC)
<http://www.auc.ab.ca>

Alberta Utilities Commission (AUC) Rule 007 checklist for small power plant applications and exemptions
<http://www.auc.ab.ca/acts-regulations-and-auc-rules/rules/Documents/Rule%20007/Electric%20small%20power%20plant-exemption%20checklist%20April%2021%202011.doc>

Alberta Utilities Commission (AUC) Rule 007
<http://www.auc.ab.ca/acts-regulations-and-auc-rules/rules/Documents/Rule007.pdf>

Alberta Utilities Commission (AUC) Rule 012
<http://www.auc.ab.ca/acts-regulations-and-auc-rules/rules/Documents/Rule012.pdf>

Alberta Utilities Commission (AUC) Micro Generation Regulations
<http://www.auc.ab.ca/acts-regulations-and-auc-rules/acts-and-regulations/Documents/EUA/AR288-2009.pdf>

Alberta Utilities Commission (AUC) Digital Data Submission (DDS) User Guide
<http://www.auc.ab.ca/applications/filing-an-application/Documents/DDS%20User%20Guide.pdf>

Government of Alberta
<http://www.alberta.ca>

















NAV Canada
<http://www.navcanada.ca>









Retailer and WSP list

Utilities Consumer Advocate
(Provided by government of Alberta)
<http://ucahelps.alberta.ca/energy-companies.aspx>

Utilities Consumer Advocate
www.ucahelps.gov.ab.ca

Appendix D – Certification marks

Certification Body	Certification Marks	
CSA International		<p>The CSA certification mark alone without any identifier indicates products approved to Canadian national standards. If another country's identifier is present (i.e., US, NRTL), then the small 'C' Canadian identifier is required to indicate that the product also complies with Canadian national standards.</p>
	 	
Curtis-Straus LLC		<p>The Curtis-Straus LLC certification mark requires the small 'C' Canadian identifier at the 8 o'clock position to indicate compliance to Canadian national standards.</p>
ETL Intertek Entela	 	<p>The ETL Intertek Entela certification mark requires the small 'C' Canadian identifier at the 8 o'clock position to indicate compliance to Canadian national standards.</p> <p>Identifiers for other countries may be present but in all cases, the small 'C' is required.</p>
ETL Intertek Semko	 	<p>ETL Intertek Semko has two certification marks, the ETL mark and the WH mark. Each mark requires the small 'C' Canadian identifier to indicate compliance to Canadian national standards.</p> <p>Identifiers for other countries may be present but in all cases, the small 'C' is required.</p>
	 	
	 	
FM Approvals	 	<p>The FM certification mark requires the small 'C' Canadian identifier to indicate compliance to Canadian national standards.</p> <p>Identifiers for other countries may be present but in all cases, the small 'C' is required.</p>
LabTest Certification Inc.	 	<p>The Labtest Certification Inc. certification mark requires the small 'C' Canadian identifier to indicate compliance to Canadian national standards.</p> <p>Identifiers for other countries may be present but in all cases, the small 'C' is required.</p>
Met Laboratories		<p>The MET certification mark requires the small 'C' Canadian identifier to indicate compliance to Canadian national standards.</p> <p>Identifiers for other countries may be present but in all cases, the small 'C' is required.</p>

Nemko Canada Inc.		<p>The Nemko certification mark requires the small 'C' Canadian identifier at the 8 o'clock position to indicate compliance to Canadian national standards.</p>
NSF International		<p>The NSF International certification mark requires the small 'C' Canadian identifier to indicate compliance to Canadian national standards.</p> <p>Identifiers for other countries may be present but in all cases, the small 'C' is required.</p>
OMNI-Test Laboratories, Inc.		<p>The OMNI-Test Laboratories Inc. certification mark requires the small 'C' Canadian identifier to indicate compliance to Canadian national standards.</p> <p>Identifiers for other countries may be present but in all cases, the small 'C' is required.</p>
Quality Auditing Institute		<p>The QAI certification mark requires the small 'C' Canadian identifier to indicate compliance to Canadian national standards.</p> <p>Identifiers for other countries may be present but in all cases, the small 'C' is required.</p>
QPS Evaluation Services Inc.		<p>The QPS certification mark requires the small 'C' Canadian identifier to indicate compliance to Canadian national standards.</p> <p>Identifiers for other countries may be present but in all cases, the small 'C' is required.</p>
TÜV Rheinland of North America		<p>The TÜV Rheinland certification mark requires the small 'C' Canadian identifier to indicate compliance to Canadian national standards.</p> <p>Identifiers for other countries may be present but in all cases, the small 'C' is required.</p>
TÜV Product Service		<p>The TÜV Product Service certification mark requires the small 'C' Canadian identifier to indicate compliance to Canadian national standards.</p> <p>Identifiers for other countries may be present but in all cases, the small 'C' is required.</p>
Underwriters' Laboratories		<p>The UL certification mark requires the small 'C' Canadian identifier to indicate compliance to Canadian national standards.</p> <p>Identifiers for other countries may be present but in all cases, the small 'C' is required.</p>
		<p>The ULC certification mark is a Canada-only mark indicating compliance to Canadian national standards. It does not require a small 'C' Canadian identifier.</p>

Appendix E – Single-line diagram (indicate size)

The following two single-line diagram forms are for your use. Submit one of the following forms with your MG application.

SLD No. 1

- Notes:**
1. Wiring arrows indicate direction of electrical energy flow.
 2. Grid-connection safety requirements are given by the Canadian Electrical Code Section 84, and the Wires Service Provider.
 3. All components shall meet Canadian electrical product certification standards.
 4. All components shall contain nameplate labels indicating the acceptable Certifying Organization.
 5. An inverter with a Canadian Certification Mark thus meets the CSA's standard C22.2 No. 107.1 for utility grid-connection.
 6. Separate Grid Disconnect is optional and may or may not be required by the Wires Service Provider.
 7. If installed, Grid Disconnect shall comply with Canadian Electrical Code Rule 84-024 (2006).
 8. Generator Disconnect and Grid Disconnects may be integral to the inverter.

Mini Micro-Generation Source

- Solar PV DC
- Micro-wind DC or AC
- Stirling engine DC or AC
- Micro-hydro DC or AC
- Biomass DC or AC
- Fuel cell DC
- Other: _____

Type of Generator Interface

- DC to AC Inverter
- AC to DC to AC Inverter
- Non-Inverter with anti-islanding protection (equivalent to inverter)

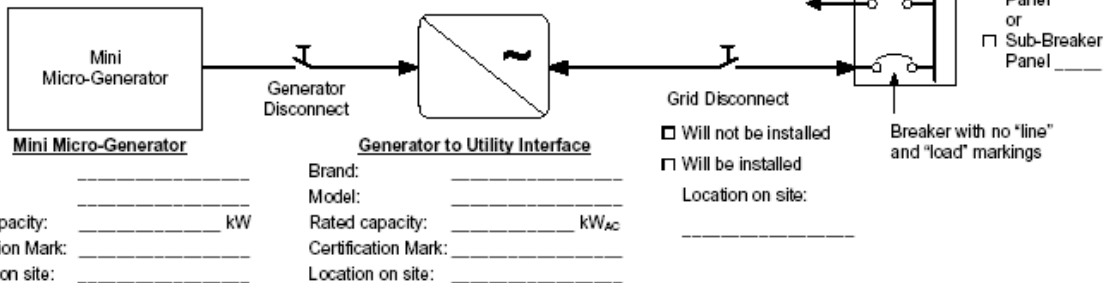

Mini Micro-Generator
 Brand: _____
 Model: _____
 Rated capacity: _____ kW
 Certification Mark: _____
 Location on site: _____

Generator to Utility Interface
 Brand: _____
 Model: _____
 Rated capacity: _____ kW_{AC}
 Certification Mark: _____
 Location on site: _____

Will not be installed
 Will be installed
 Location on site: _____

	Site Name: _____	Drawn by: _____
	Single Line Diagram for Grid-Dependent, Mini Micro-Generator Connected to the Wires Service Provider's Electrical Distribution System	Drawing Date: _____
	This single line diagram is intended for use in permitting and grid-connection approvals. It is not intended to be used for system design or installation.	Site Description: _____
	DRAWING NO. _____ REV _____ SCALE: NOT TO SCALE	Site Location: _____

Diagram Courtesy of Howell-Mayhew Engineering

SLD No. 2(indicate size)

Notes:

1. Wiring arrows indicate direction of electrical energy flow.
2. Grid-connection safety requirements are given by the Canadian Electrical Code Section 84, and the Wires Service Provider.
3. All components shall meet Canadian electrical product certification standards.
4. All components shall contain nameplate labels indicating the acceptable Certifying Organization.
5. An inverter with a Canadian Certification Mark thus meets the CSA's standard C22.2 No. 107.1 for utility grid-connection.
6. Separate Grid Disconnect is optional and may or may not be required by the Wires Service Provider.
7. If installed, Grid Disconnect shall comply with Canadian Electrical Code Rule 84-024 (2006).

Mini Micro-Generation Source

- Solar PV
- Micro-wind
- Stirling engine
- Micro-hydro
- Biomass
- Fuel cell
- Other: _____

Mini Micro-Generator

Brand: _____
 Model: _____
 Rated capacity: _____ kW_{DC}
 Certification Mark: _____
 Location on site: _____

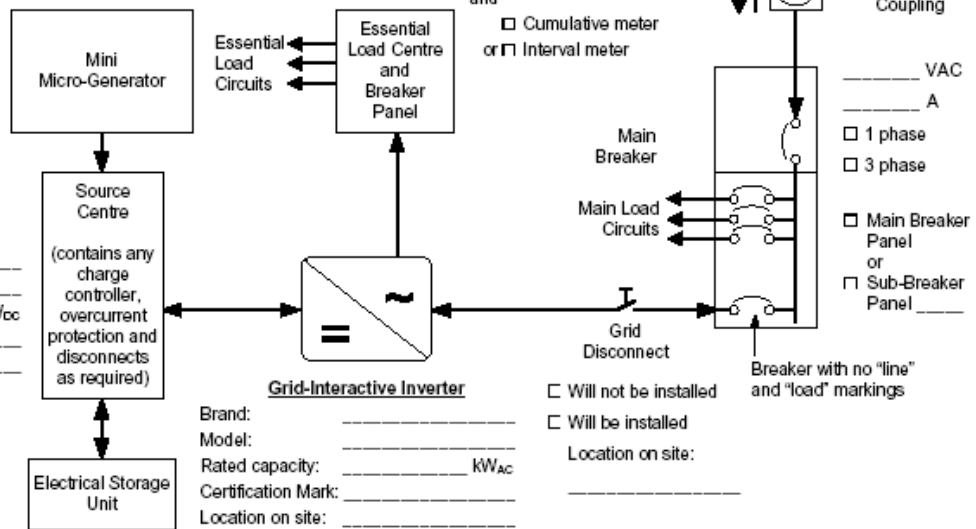

	Site Name: _____	Drawn by: _____
	Single Line Diagram for Grid-Interactive, Mini Micro-Generator Connected to the Wires Service Provider's Electrical Distribution System	Drawing Date: _____
	This single line diagram is intended for use in permitting and grid-connection approvals. It is not intended to be used for system design or installation.	Site Description: _____
	DRAWING NO. _____ REV _____ SCALE: NOT TO SCALE	Site Location: _____

Diagram Courtesy of Howell-Mayhew Engineering

Appendix F – Interconnection and operating agreement sample

The following two documents are samples only. They are provided in order to familiarize you with a Wire Service Provider's Interconnection Agreement.

Sample No. 1 - Interconnection and operating agreement (less than 10 kw inverter based)

Distribution company's letterhead

This template is generic. Each wire service provider will use their specific format.

In consideration of <Utility Name Here> (the "**wires owner**") agreeing to allow you to connect your inverter-based 10 kW or smaller installed capacity generation facility located at (**land location**) (your "**generation facility**") to the wires owner's distribution system, you hereby agree to the following terms and conditions.

1.0 Eligibility

1.1 You agree that the connection between your generation facility and the wires owner's distribution system will be subject to all applicable laws and bound by the wires owner terms and conditions of service (the "**terms of service**"), which are filed with, and approved by, the Alberta Utilities Commission ("**AUC**") from time to time, and which are available to you on request.

1.2 You certify that you meet all of the requirements of AUC Rule 024.

2.0 Technical Requirements

2.1 You represent and warrant that you have installed, or covenant that you will: (a) install prior to the connection of your inverter based generation facility to the wires owner's distribution system; and (b) maintain thereafter in accordance with and for the duration of this agreement, an inverter satisfying Section 84 of the Canadian Electrical Code and CSA C22.2 No. 107.1-01 (General Use Power Supplies) or UL 1741.

2.2 You covenant and agree to perform regularly-scheduled maintenance to your generation facility as outlined by its manufacturer in order to assure that its connection devices, protection systems, and control systems are maintained in good working order and in compliance with all applicable laws.

2.3 You agree to the automatic disconnection of your generation facility from the wires owner's distribution system in the event of: (a) a planned or unplanned power outage on the wires owner's distribution system, (b) any abnormal operation of the wires owner's distribution system, (c) a direction from the independent system operator ("**ISO**") or other governmental authority, or (d) any other event that requires such disconnection pursuant to the terms of service, applicable law or good electricity practice.

2.4 You covenant and agree that the design, installation, maintenance, and operation of your generation facility will be conducted in a manner that ensures the safety and security of both the generation facility and the wires owner's distribution system.

2.5 Due to the wires owner's obligation to maintain the safety and reliability of its distribution system, you covenant and agree that in the event you determine or the wires owner determines, in its sole opinion, acting reasonably, that your generation system facility is or is reasonably likely to: (i) cause damage to; and/or (ii) adversely affect other distribution system customers or the wires owner's assets, you will disconnect your

generation facility immediately from the wires owner's distribution system upon direction from the wires owner and correct the problem at your own expense prior to reconnection.

2.6 You represent and warrant that the total generation capacity of your generation facility is **(insert capacity)**. You covenant and agree that you will not make any alteration to the design or operation of your generation facility, including, but not limited to, the total generation capacity of your generation facility, without the prior written approval of the wires owner.

2.7 You hereby grant the wires owner access to your generation facility, including for purposes of inspection, maintenance, operation and meter reading.

3.0 Liabilities

3.1 You will indemnify and hold the wires owner harmless from and against all costs, expenses, damages, claims, liabilities and adverse effects resulting from your breach of this agreement and from your negligence or willful misconduct in connection with the operation of your generation facility or the interconnection between your generation facility and the wires owner's distribution system.

3.2 Notwithstanding Section 3.1, you shall not be liable to the wires owner under any circumstances whatsoever for any loss of profits or revenues, business interruptions losses, loss of contract or loss of goodwill, or for any indirect, consequential, incidental or special damages, including but not limited to punitive or exemplary damages, whether any of the said liability, loss or damages arise in contract, tort or otherwise. For purposes of this agreement, damages claimed by third parties shall not be considered indirect, consequential, incidental or special damages, regardless of the type of damages being claimed.

3.3 The wires owner's liability to you, whether pursuant to contract, tort or otherwise, shall be limited to the liability imposed on the wires owner pursuant to the Terms of Service. Nothing in this agreement is intended to abrogate, alter or diminish the statutory liability protection granted to the wires owner under the *Electric Utilities Act* (Alberta) and the *Liability Protection Regulation* (Alberta).

4.0 Termination

4.1 You may terminate this agreement at any time by: (a) disconnecting your generation facility from the wires owner's distribution system, and (b) thereafter giving the wires owner 30-days written notice of such termination.

4.2 The wires owner may terminate this agreement on 30-days notice upon the occurrence of any of the following: (a) your disposition of your generation facility or your interest in the property on which it resides; (b) your breach of this agreement; (c) the retirement of the wires owner's distribution system; and (d) any change in law that affects the wires owner's rights or obligations under the *Micro-Generation Regulation* (Alberta) or AUC Rule 024.

5.0 Assignment

5.1 You agree that this agreement constitutes an interest in land with respect to the lands on which your generation facility is located, and that the wires owner may register this agreement at the appropriate land titles office against title to the lands on which your generation facility is located.

5.2 You covenant and agree that you will not sell, assign, transfer, convey or otherwise dispose of your generation facility or your interest in the property on which it resides without the prior written consent of the wires owner, which shall not be unreasonably withheld. It will be a condition of the wires owner's consent that the new owner of your generation facility or your interest in the property on which it resides

be assigned your rights and obligations under this agreement. The wires owner may assign its rights and obligations under this agreement without your consent.

5.3 In addition, you agree that if your rights and obligations under this agreement are not assigned to the new owner of your generation facility or your interest in the property on which it resides, the wires owner may send a micro-generation decommission notification (GRN transaction) to your retailer prohibiting any further generation credits to be processed with respect to your generation facility until a new agreement is reached between the wires owner and the new owner of your generation facility.

Approved by:

Wires owner signature: _____ Date: _____

MG customer signature: _____ Date: _____

SAMPLE No. 2 Interconnection and operating agreement (small micro-generator)

Distribution company's letterhead

This template is generic. Each wire service provider will use their specific format.

This agreement between _____ (the "**MG customer**") and _____ (the "**wires owner**") is intended to provide for the safe and orderly operation of the electrical facilities interconnecting the MG Customer's generation facility at (**land location and description of project**) and the electrical distribution system owned by the wires owner. It is the intent of the MG customer to generate electricity primarily for its own use sized to the customer's load or portion thereof, and to be reimbursed for any excess generation. It is the intent of the wires owner to operate its distribution system to maintain a high level of power quality and service for its customers. It is the intent of both parties to operate their respective facilities in a way that ensures the safety of the public and their respective employees.

1. Relation to other documents:

This agreement does not supersede any requirements outlined in any government regulations, including (but not limited to) the *Alberta Electric and Communication Utility Code*, the *Canadian Electrical Code* and the *Alberta Occupational Health and Safety Act*, nor does it supersede the wires owner's safety policies and procedures or the terms of the [**commercial contract**] between the MG customer and the wires owner or any of its affiliates.

2. Operating authority:

The operating authority for each of the parties hereto is the person identified by name or job title responsible to establish operating procedures and standards within their organization. The operating authorities for the MG customer and for the wires owner shall ensure that timely updates are made to this document to reflect any changes to system operating characteristics, disconnect devices and single line diagrams referenced in this agreement. The operating authorities for the MG customer and for the wires owner shall ensure that the operators of the generation facility and the distribution system are competent in the respective operation thereof and are aware of the provisions of any operating agreements, laws, regulations and rules relating to the safe operation of electrical power systems.

The operating authority for the MG customer is (**name or title of person designated the operating authority, their address and phone numbers**).

The operating authority for the wires owner is (**name or title of person designated the operating authority, their address and phone numbers**).

3. Operator in charge:

The operator in charge for each of the parties hereto is the person identified by name or job title responsible for the real time operation of all electrical facilities related to the interconnection between the MG customer's generation facility and the wires owner's distribution system.

The operator in charge for the MG customer is (**name or title of person designated the operator in charge, their address and phone numbers**).

The operator in charge for the wires owner is (**name or title of person designated the operator in charge, their address and phone numbers**).

4. Description of facilities:

The point of common coupling is designated as **(description of point of common coupling)**, and is identified on the attached single-line diagram.

The **(breaker, switch etc.) (switch number)** will be used as the main disconnect point (visible/lockable) for the MG customer's generation facility, and is owned and operated by **(specify owner/operator here)**. This switch **(does/does not)** have load-break capability and therefore **(can/cannot)** be operated while the generation facility is producing or consuming power.

The MG customer's generation facility consists of a **(size), (type), (connection)** generator. **(The MG customer)** owns and is responsible for the maintenance and operation of all facilities on the generator side of the point of common coupling.

The wires owner's distribution system consists of **(distribution size voltage) kV line (line number)** and a **(transformer size), (transformer connection designation)** transformer. The wires owner owns and is responsible for the operation of all facilities on the distribution side of the point of common coupling.

The MG customer's generation facility is designed to operate while connected to the Alberta electricity grid, with synchronizing facilities provided on the MG customer's breaker **(breaker number)**. In the absence of outstanding clearances between the operators in charge, notice will not be required to be given to the wires owner prior to synchronization of the MG customer's generation facility and the wires owner's distribution system taking place. It is recognized by the MG customer that there are no synchronization schemes in place on the wires owner's distribution system, and that the **(upstream distribution facility)** contains automatic equipment that will provide for voltage regulation or automatic re-closure under some conditions. **(Insert description of any special blocking or protection schemes.)**

The MG customer's generation facility is capable of controlling either voltage or power factor, and is normally set to control **(voltage or power factor)** to **(setting, tolerance)** at the generation facility's terminals.

5. Suspension of interconnection:

The operation of the MG customer's generation facility and the quality of electric energy supplied by the MG customer shall meet both the standards and anti-islanding requirements as specified in Part 2 of the *Alberta Distributed Generation Interconnection Guide* and any further standards identified by the wires owner. If the operation of the MG customer's facilities or quality of electric energy supplied does not meet the above standards or, in the event you determine or the wires owner determines, in its sole opinion, acting reasonably, that your generation facility is or is reasonably likely to: (i) cause damage to; and/or (ii) adversely affect other distribution system customers or the wires owner's assets, the wires owner will notify the MG customer of same and the MG customer shall promptly take all reasonable corrective action at its sole cost and expense. The wires owner may, in its sole discretion and without notice, disconnect the MG customer's facilities from the wires owner's distribution system until all such correction action and/or compliance with the above standards is reasonably demonstrated.

Additionally, the wires owner may, in its sole discretion and without notice, disconnect the MG customer's generation facility from the wires owner's distribution system in the event of: (a) a planned or unplanned power outage on the wires owner's distribution system, (b) any abnormal operation of the wires owner's distribution system, (c) a direction from the independent system operator ("ISO") or other governmental authority, or (d) any other event that requires such disconnection pursuant to: (i) the wires owners' terms and conditions of service (the **"terms of service"**), which are filed with, and approved by, the Alberta Utilities Commission from time to time; (ii) applicable law, or (iii) good electricity practice.

6. Safe work planning:

Safe work planning practices such as pre-job plans and tailboard conference procedures shall be followed whenever both parties are involved in work on the interconnected system. Nothing in this agreement shall be interpreted as altering the intent of the wires owner's safe practices manual or safe operating procedures. Safe work routines described in Division D of the *Alberta Electrical and Communication Utility Systems Regulations* shall be followed when providing isolation for work on any part of the interconnected system.

7. Technical requirements:

MG customer covenants and agrees that it will not make any alteration to the design and operation of its generation facility, including, but not limited to, the total generation capacity, voltage and frequency of its generation facility, without the prior written approval of the wires owner.

8. Maintenance outages:

Maintenance outages will occasionally be required on the wires owner's distribution system and the MG customer's generation facility. Both parties hereto are required to provide reasonable notice, given the circumstances, and plan to minimize downtime. It is recognized that in some emergency cases, such notice may not be possible. Outages shall be coordinated by the operators in charge.

9. Liabilities:

The MG customer will indemnify and hold the wires owner harmless from and against all costs, expenses, damages, claims, liabilities and adverse effects resulting from the MG customer's breach of this agreement, negligence or willful misconduct in connection with the operation of the MG customer's generation facility or the interconnection between the MG customer's generation facility and the wires owner's distribution system.

Notwithstanding the foregoing, the MG customer shall not be liable to the wires owner under any circumstances whatsoever for any loss of profits or revenues, business interruptions losses, loss of contract or loss of goodwill, or for any indirect, consequential, incidental or special damages, including but not limited to punitive or exemplary damages, whether any of the said liability, loss or damages arise in contract, tort or otherwise. For purposes of this agreement, damages claimed by third parties shall not be considered indirect, consequential, incidental or special damages, regardless of the type of damages being claimed.

The wires owner's liability to the MG customer, whether pursuant to contract, tort or otherwise, shall be limited to the liability imposed on the wires owner pursuant to the terms of service. Nothing in this agreement is intended to abrogate, alter or diminish the statutory liability protection granted to the wires owner under the *Electric Utilities Act (Alberta)* and the *Liability Protection Regulation (Alberta)*.

10. Access:

The wires owner shall have access to the MG customer's generation facilities, including for purposes of inspection, maintenance, operation and meter reading. Access and inspections shall be arranged by the operators in charge.

11. Termination:

The MG customer may terminate this agreement at any time by: (a) disconnecting its generation facility from the wires owner's distribution system, and (b) thereafter giving the wires owner 30 days' written notice of such termination.

The wires owner may terminate this agreement on 30 days' notice upon the occurrence of any of the following: (a) the MG customer's disposition of its generation facility or its interest in the property on which it resides; (b) the MG customer's breach of this agreement; (c) the retirement of the wires owner's distribution system; and (d) any change in law that affects the wires owner's rights or obligations under the *Micro-Generation Regulation (Alberta)* or AUC Rule 024.

12. Assignment:

The MG customer agrees that this agreement constitutes an interest in land with respect to the lands on which the MG customer's generation facility is located, and that the wires owner may register this agreement at the appropriate land titles office against title to the lands on which the MG customer's generation facility is located.

The MG customer covenants and agrees that it will not sell, assign, transfer, convey or otherwise dispose of its generation facility or its interest in the property on which its generation facility resides without the prior written consent of the wires owner, which shall not be unreasonably withheld. It will be a condition of the wires owner's consent that the new owner of the MG customer's generation facility or its interest in the property on which its generation facility resides be assigned the MG customer's rights and obligations under this agreement. The wires owner may assign its rights and obligations under this agreement without the MG customer's consent.

In addition, the MG customer agrees that if its rights and obligations under this agreement are not assigned to the new owner of its generation facility or its interest in the property on which its generation facility resides, the wires owner may send a micro-generation decommission notification (GRN transaction) to the MG customer's retailer prohibiting any further generation credits to be processed with respect to the MG customer's generation facility until a new agreement is reached between the wires owner and the new owner of the MG customer's generation facility.

Approved by:

Wires owner signature: _____ Date: _____

MG customer signature: _____ Date: _____

Appendix H – Form A, Micro-generation project notice

< Enter Wire Service Provider Name Here >

Please check one of the following boxes:

Mini MG - Inverter-based - 10 kW and smaller (refer to the Application Guidelines, www.auc.ab.ca, for clarification)

Small MG - From 0 kW to 150 kW (Note: For small MG, please indicate fields denoted with *)

Large MG - Greater than 150 kW and less than 1 MW (Note: For large MG, please fill in fields denoted with **)

APPLICANT IDENTIFICATION			
Name:		**Company Name:	
		** Business Associate Code:	
Address:		City:	
Province:	Postal Code:	Phone:	Fax:
e-mail:		Preferred method of contact: E-mail <input type="checkbox"/> Mail <input type="checkbox"/> Fax <input type="checkbox"/>	
Consultant Name:		Consultant Phone:	
Consultant Address/City/Province/Postal Code:			
Other Interested Parties:			
PROJECT DESCRIPTION			
Legal Land Description:		Site ID:	
Service Address:		Retailer Name:	
Have you notified your retailer about your MG project? Yes <input type="checkbox"/> No <input type="checkbox"/>			
Generator Type: Solar <input type="checkbox"/> Wind <input type="checkbox"/> Hydro <input type="checkbox"/> Biomass <input type="checkbox"/> Fuel cell <input type="checkbox"/> Other <input type="checkbox"/> Specify:			
Generator To Utility Interface: * Inverter <input type="checkbox"/> * Non-Inverter <input type="checkbox"/> ** Induction <input type="checkbox"/> ** Synchronous <input type="checkbox"/>			
Generator Rated Capacity (kW):	** Demand (kVA):	Customer Annual Usage (kWh):	
Voltage level of connection:		Phase: Single <input type="checkbox"/> Three <input type="checkbox"/>	
Is the energy produced to be used primarily by the generator owner? Yes <input type="checkbox"/> No <input type="checkbox"/>			
** Does your generator unit satisfy Anti-Islanding Clause CSA Standard C22.2 107.1? Yes <input type="checkbox"/> No <input type="checkbox"/>			
Does your generator meet MG Regulation's Renewable/Alternative Energy Definition? Yes <input type="checkbox"/> No <input type="checkbox"/>			
Requested In Service Date (YY-MM-DD):			
SUPPORTING DOCUMENTS ATTACHED:			
Electric single-line diagram: Yes <input type="checkbox"/> No <input type="checkbox"/>		Site Plan: Yes <input type="checkbox"/> No <input type="checkbox"/>	
Has an electrical permit been obtained? Yes <input type="checkbox"/> Not yet <input type="checkbox"/>			
Have you met all applicable municipal and zoning requirements, including noise rules? Yes <input type="checkbox"/> No <input type="checkbox"/>			
Applicant Signature:		Date Of application:	
WIRE SERVICE PROVIDER USE ONLY:			
Wires owner's application reference #:		** AESO Asset ID:	
Received by:		Interconnection Line:	
Approval: Yes <input type="checkbox"/> No <input type="checkbox"/> -- Reason(s) for disapproval:			
Interconnection Agreement Signed? Yes <input type="checkbox"/> No <input type="checkbox"/> Not Applicable <input type="checkbox"/>			
Meter type: Interval <input type="checkbox"/> Cumulative <input type="checkbox"/>		Substation Number:	
Meter Installed Date:			

When completed, send the form to your Distribution Company. The address can be found in Application Guide.

Appendix H – Form B, Notice of dispute

To be completed by applicable owner when there is a dispute with respect to the customer’s eligibility of becoming a micro-generator. Information required must include the following:

Contact person who submits the dispute notice:	Name:
	Phone:
Is applicable owner represented by other party?	Yes <input type="checkbox"/> No <input type="checkbox"/> If yes, provide name and contact information
Attached a copy of the MG project notice (Form A):	Yes <input type="checkbox"/> No <input type="checkbox"/>
Type of rejection:	<input type="checkbox"/> Qualification (MG Regulation - Section 2.2) <input type="checkbox"/> Extraordinary costs (MG Regulation – Section 4.3)
If dispute is related to Section 2.2, has owner served notice on customer within 14 days?	Yes <input type="checkbox"/> No <input type="checkbox"/>
Rejection rationale:	
Other information attached:	

Date of submitting this notice _____

Appendix H – Form C, Notice of complaint

To be completed by customer when there is complaint on the metering cost. Information required must include the following:

Contact person who submits the complaint notice:	Name:
	Phone:
If customer is represented by other party?	Yes <input type="checkbox"/> No <input type="checkbox"/> If yes, provide name and contact information:
Attached a copy of the MG project notice (Form A):	Yes <input type="checkbox"/> No <input type="checkbox"/>
Type of complaint:	<input type="checkbox"/> Interval metering costs (MG Regulation Section 3 (5))
Provide full details of the complaint:	
Other Information attached:	

Date of submitting this notice _____

Appendix I – How to apply for a BA code (Business Associate Identifier)

To apply for a BA Code you must fill out the Petroleum Registry Online form.

<http://www.petroleumregistry.gov.ab.ca/PR.asp>

1. Choose **Apply for Access** at the bottom of their homepage
2. Choose **Apply for Access** in the box at the bottom of the next page
3. You should see a page that looks like this at the top:

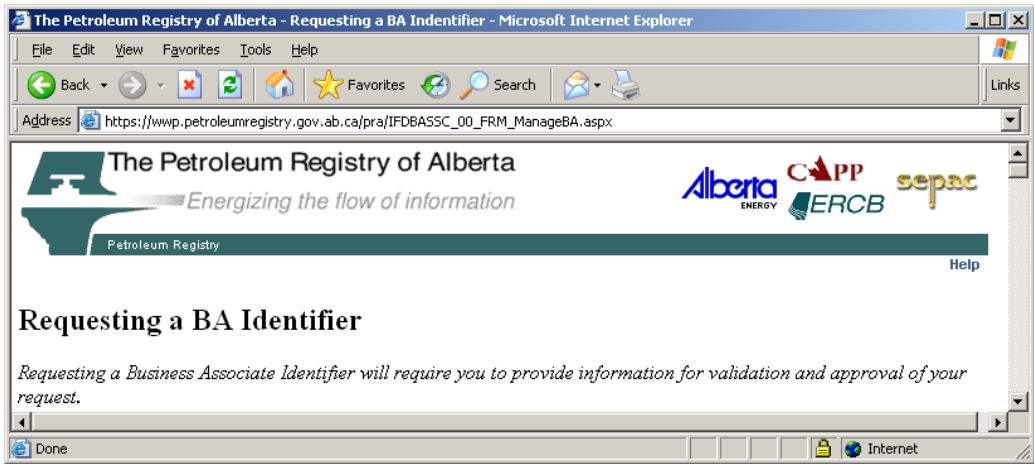

(Direct Link: https://www.petroleumregistry.gov.ab.ca/pr/IFDBASSC_00_FRM_ManageBA.aspx)

Notes for Filling Out the Application

1. General Information Section

- Note: although the form indicates that all fields marked with a * are mandatory, you only need to fill out the Company name OR the Individual name

2. BA User Security Administrator Information Section

- Choose **No**

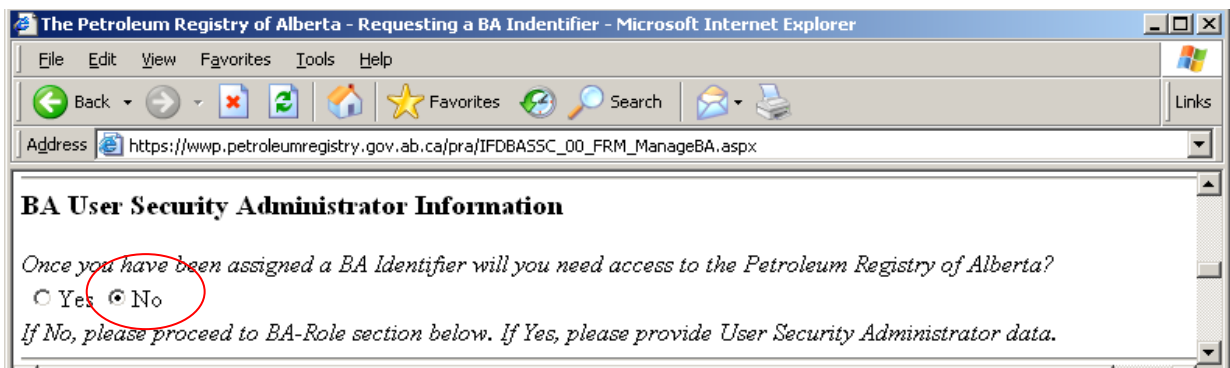

- Choose **Digital Data System (DDS)**

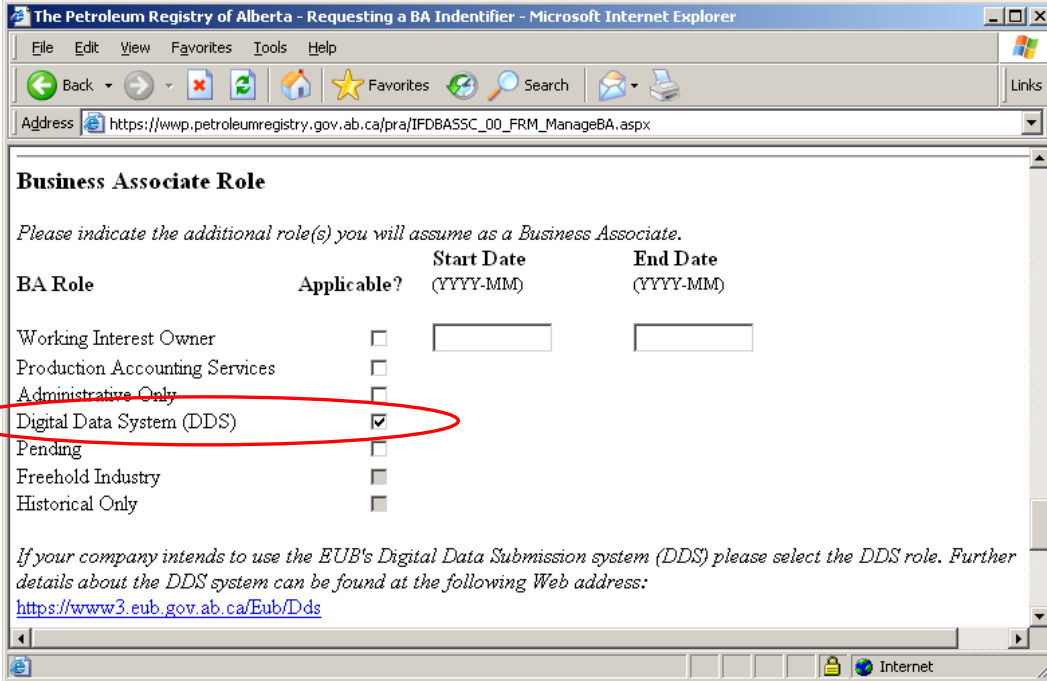

The Petroleum Registry of Alberta - Requesting a BA Identifier - Microsoft Internet Explorer

Address: https://www.petroleumregistry.gov.ab.ca/prai/IFDBASSC_00_FRM_ManageBA.aspx

Business Associate Role

Please indicate the additional role(s) you will assume as a Business Associate.

BA Role	Applicable?	Start Date (YYYY-MM)	End Date (YYYY-MM)
Working Interest Owner	<input type="checkbox"/>		
Production Accounting Services	<input type="checkbox"/>		
Administrative Only	<input type="checkbox"/>		
Digital Data System (DDS)	<input checked="" type="checkbox"/>		
Pending	<input type="checkbox"/>		
Freehold Industry	<input type="checkbox"/>		
Historical Only	<input type="checkbox"/>		

If your company intends to use the EUB's Digital Data Submission system (DDS) please select the DDS role. Further details about the DDS system can be found at the following Web address:
<https://www3.eub.gov.ab.ca/Eub/Dds>

4.

- Choose **No** (licences only for gas wells)

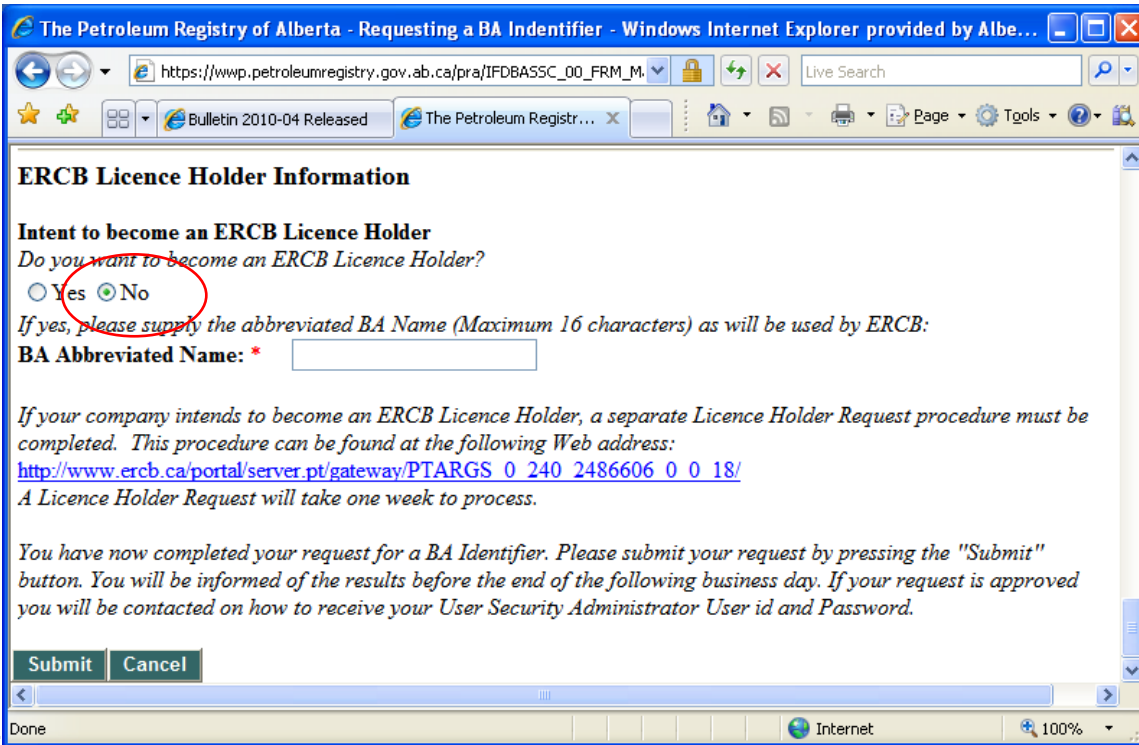

The Petroleum Registry of Alberta - Requesting a BA Identifier - Windows Internet Explorer provided by Albe...

Address: https://www.petroleumregistry.gov.ab.ca/prai/IFDBASSC_00_FRM_M...

ERCB Licence Holder Information

Intent to become an ERCB Licence Holder

Do you want to become an ERCB Licence Holder?

Yes No

If yes, please supply the abbreviated BA Name (Maximum 16 characters) as will be used by ERCB:

BA Abbreviated Name: *

If your company intends to become an ERCB Licence Holder, a separate Licence Holder Request procedure must be completed. This procedure can be found at the following Web address:
http://www.ercb.ca/portal/server.pt/gateway/PTARGS_0_240_2486606_0_0_18/

A Licence Holder Request will take one week to process.

You have now completed your request for a BA Identifier. Please submit your request by pressing the "Submit" button. You will be informed of the results before the end of the following business day. If your request is approved you will be contacted on how to receive your User Security Administrator User id and Password.

4.

Registry Service Desk

Questions related to the submission to or retrieval of information from the registry should be directed to the Petroleum Registry.

Phone: 403-297-6111 (in Calgary)

Phone: 1-800-992-1144 (other locations)

Fax: 403-297-3665

Email: petroleumregistry.energy@gov.ab.ca

Appendix J – Electrical safety

Any system that produces electricity can be potentially dangerous, creating the possibility of electrocution and fire hazards. Improperly installed systems will create serious safety hazards to property owners, families and WSP workers.

All precautions must be taken to ensure the installation and operation of the applicant's MG is governed by health and safety standards. This includes ensuring that all safety information is kept up to date.

Before MG installation, it is imperative to understand and follow the safety requirements including but not limited to:

Equipment approved by the Canadian Electrical Code (CEC). Manufacturers of all electrical products are required to certify their products to the appropriate Canadian product safety standards. Compliance to these standards is indicated by a mandatory certification mark located on the MG equipment's nameplate.

Alberta's STANDATA Standata Electrical Information Safety Bulletin LEG-ECR-2 [Rev 16] indicates the acceptable Certification Marks. Equipment that does not carry the appropriate certification mark is not permitted to be sold or installed. See Appendix D for details.

See also <http://www.municipalaffairs.alberta.ca/documents/ss/STANDATA/electrical/330-LEG-ECR-2unsigned.pdf>

Grid-connected inverters are required to be approved to Clause 15 of the Canadian Standards Association (CSA) inverter standard. (C22.2 No.107.1) Clause 15 of this standard ensures that the inverter will properly shut down during a power outage. This shut down is called 'anti-islanding' and is of utmost importance to Wire Service Providers.

If inverters carry a certification mark that is complete and identical to one of the marks in Appendix D, then the inverter has been certified to CSA inverter standard C22.2 No.107.1.

For certification concerns or inquiries, contact the Equipment Manufacturer, WSP or CSA directly at

certinfo@csa-international.org or 416.747.2661 or 1.866.797.4272. System Installed According to the Canadian Electrical Code

MGs need to be designed and installed according to the minimums laid out by the CEC. Your MG installer needs to be qualified to do this. Note Section 84 of the CEC and its rules regarding the need for warning notices and disconnects on MGs.

Extreme caution must be exercised to avoid electric shock. Your installer must conform to the equipment manufacturer's installation instructions to ensure all necessary safety precautions are applied at all times.

Most mini and small MGs use inverter interfaces. Grid-connected inverter-based units are certified to shut down during outages in the electrical distribution system. Inverter-based mini MGs do not require the disconnecting means in CE Code Rule 84-024 (c) to have contact operation by direct visible means.

Equipment documentation

The equipment installation and operating instructions should contain the contact details for the manufacturer, equipment supplier and the installer.

Small and large MGs must also include documentation confirming that they meet Canada's standard for anti-islanding which is CSA C22.2 No. 107-1. For mini MGs the certification mark will suffice.

Inspection * **

Small or large MG owners must maintain a quality control and inspection program according to the manufacturer's recommendations. MG owners must supply their WSP with a complete set of detailed drawings which the WSP will use to assist in the MG inspection.

Maintenance

Routine maintenance of MGs is the full responsibility of the MG owner. The complete system, control and protective equipment must be in accordance with the manufacturer's recommendations. Maintenance records are required.

Appendix K - Electrical contractor and electrical inspection

Electrical contractor

It is highly recommended that you hire a qualified electrical contractor to install your MG. Extreme caution must be exercised to avoid electric shock.

Reference must be made to the manufacturer's instructions to ensure all necessary safety precautions are applied at all times. Applicants are advised to ensure that their electrical contractor also has the following:

- Municipal business and/or contractors licence (where required)
- Adequate liability insurance
- References

Ask about the amount of experience the electrical contractor has in installing MGs. These systems are relatively new and not many electrical contractors have experience installing these types of systems. The electrical contractor will need to install your MG according to all required regulations and standards.

Electrical inspection

Before the MG can be connected to the WSP's electrical distribution system it must be inspected by an electrical inspector. The inspection provides assurance that the installation meets the safety requirements of the Canadian Electrical Code (CEC) and does not pose a hazard to MG owners, their families, friends, or employees. It also provides an assurance that the installation will not be a hazard to WSP workers who may be required to service or repair the electrical supply to the MG owner's farm, home or business.

The inspector will ensure the safety standards have been met for:

1. Approved equipment

The inspector will confirm that MG owners are using equipment approved by Part 2 of the Canadian Electrical Code and that installation is in accordance with Part 1 of the Canadian Electrical Code.

2. Disconnecting means (distributed generation (DG) system)

The inspector will verify that a second disconnect means (intended to protect utility workers) is installed if required in the location specified by the local distribution company.

The inspector will verify that this disconnect is properly sized to handle the electrical output from the inverter, and that it is wired to simultaneously disconnect all ungrounded conductors of the distributed generator from the distribution supply system.

3. Appropriate labelling

The inspector will look for required labelling as per the CEC and local regulations.